

See discussions, stats, and author profiles for this publication at: <https://www.researchgate.net/publication/271518503>

# Dual-Sweep Frequency Scanning Interferometry Using Four Wave Mixing

Article in IEEE Photonics Technology Letters · April 2015

DOI: 10.1109/LPT.2015.2390779

CITATIONS

5

READS

218

6 authors, including:



**Nigel Copner**

University of South Wales

46 PUBLICATIONS 138 CITATIONS

[SEE PROFILE](#)



**Andrew Lewis**

National Physical Laboratory

67 PUBLICATIONS 432 CITATIONS

[SEE PROFILE](#)



**Michael A. Campbell**

National Physical Laboratory

13 PUBLICATIONS 146 CITATIONS

[SEE PROFILE](#)



**Ben Hughes**

National Physical Laboratory

49 PUBLICATIONS 473 CITATIONS

[SEE PROFILE](#)

Some of the authors of this publication are also working on these related projects:



International measurement comparisons [View project](#)



Design and evaluation of novel antenna systems and novel electronic beam forming methodologies [View project](#)

# Dual-Sweep Frequency Scanning Interferometry Using Four Wave Mixing

J.J. Martinez, M. A. Campbell, M.S. Warden, E. B. Hughes, N. Copner, A. J. Lewis

**Abstract**—Frequency scanning interferometry is a well known technique to measure the distance to a reflecting target. However, variations in the optical path length during the finite measurement time severely limit the applicability of the method in real world environments. By the use of a second swept source measurements become immuneto these variations. The use of a second source implies a great increase in costs and complexity. In this paper we explore the possibility of using four wave mixing for the generation of the secondary swept frequency source. This greatly reduces the increase in costs and solves the synchronization issues often encountered by dual laser systems. A prototype has been built and tested against induced variations in the optical path length, proving the ability of the technique to improve distance measurements in industrial environments.

**Index Terms**—Distance Measurements, Sweep Laser Applications, Four Wave Mixing, FSI.

## I. INTRODUCTION

THE capacity to make high precision distance measurements in real time is particularly useful in industrial environments where large components are being assembled or machines are operating (aerospace industries or other heavy duty manufacturers). Different technologies exist to estimate distance using frequency scanning interferometry (FSI). Some FSI techniques rely on phase information for high precision measurements, though they are very sensitive to environmental conditions, such as loss of direct line of sight with the target, making them unsuitable for harsh environments [1]. Methods that rely only on frequency measurements sacrifice precision, but grant more flexibility, being preferred for industrial scenarios [2]–[4]. However single sweep frequency methods face important loss of accuracy and quality of the detection when faced with variations in the optical path length (OPL). These can be caused by vibrations in the targets and sensor heads, movements of the target, or optical path length changes due to

This work was funded by the UK National Measurement Office Engineering and Flow Metrology Programme and EMRP Project IND53. The EMRP is funded by the EMRP participating countries within EURAMET and the European Union.

J.J. Martinez and N. Copner are associated with University of South Wales, CES, Treforest, Wales, CF371DL, UK (e-mail: {jj.martinez, nigel.copner}@southwales.ac.uk).

M. Campbell, B. Hughes, A. Lewis are associated with National Physical Laboratory, Hampton Road, Teddington, Middlesex, TW110LW, UK (e-mail: {michael.campbell, ben.hughes, andrew.lewis}@npl.co.uk). M.S. Warden was with the National Physical Laboratory but now is employed elsewhere (e-mail: matthew.warden@fraunhofer.co.uk).

air turbulence over the finite measurement period. Dual sweep FSI can solve this problem [5], but it requires two different sweeping laser sources and a special and often complicated technique to synchronize both sweeps.

In this paper we propose to use four wave mixing (FWM) as a means to create a second swept laser source suitable for dual sweep FSI measurements. The generated FWM sweep is a perfectly synchronized, mirror copy of the original laser sweep. FWM is a non-linear effect that generates additional optical frequencies when at least two optical signals pass through certain optical mediums. It is very common in communications and normally seen as a negative effect (creating unwanted signals), but some applications (data switching and conversion) use the effect and thus there are devices designed to maximise the effect.

Our proposal allows a cost effective configuration for implementing dual sweep FSI measurements as only one swept frequency source is required. Synchronization issues arising from using two separate laser sources are resolved since FWM generates a perfect mirrored copy of the first laser frequency sweep.

To validate the use of FWM in dual sweep FSI, measurements were made in the presence of induced OPL variations.

## II. THEORETICAL BASE

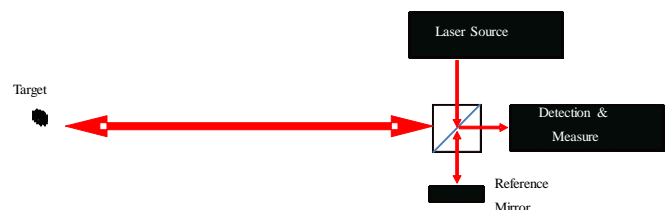

Figure 1. FSI schema

The scheme in fig. 1 shows the basic set-up for a FSI range estimation system. The swept frequency laser light is divided into two paths; in one of the paths the light is reflected by a mirror placed at a known distance and in the other the light is reflected by a target whose distance we wish to estimate. The returned light from both paths is recombined and the target distance can be found from the interference signal measured with a photodiode whilst the laser frequency is swept. Fig. 2 shows the optical frequency of these reflections vs. time of arrival to the photodiode. The time delay between signals,  $\tau$ , is directly related to the distance to the target. In practice, the frequency of beat pattern created by interference from the

reference and measurement arms is used to determine the target distance.

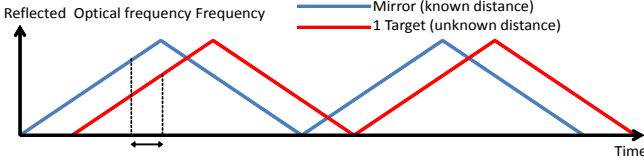

Figure 2. Optical frequency reflected from targets with the time difference  $\tau$  marked in the time axis.

Equation 1 shows the simplified electrical response of a receiver with the two reflections at the input. In ideal conditions spectral analysis of this response will give us a narrow frequency peak, the position of which can be directly related to the optical path difference in the interferometer.

$$I(t, \tau) = A \cdot \cos[2\pi(\alpha t + f_0 \tau)] \quad (1)$$

Where,  $f_0$  is the optical frequency of the swept laser at time  $t=0$ ,  $A$  is the magnitude of the signal, and  $\alpha$  is the sweep rate of the laser. If the OPL varies during a measurement,  $\tau$  becomes time dependent and the  $f_0 \tau$  term in the above translates OPL variations into unwanted phase modulations of the interference signal, drastically decreasing measurement precision. A proposed solution [5] is the use of two different swept sources (separated by polarization, wavelength or other possible means), that gives two separated beat responses:

$$\begin{aligned} I_1(t, \tau) &= A_1 \cdot \cos[2\pi(\alpha_1 t + f_0^1 \tau)] \\ I_2(t, \tau) &= A_2 \cdot \cos[2\pi(\alpha_2 t + f_0^2 \tau)] \end{aligned} \quad (2)$$

Multiplying both expressions produces the following:

$$\begin{aligned} I(t, \tau) &= A_3 \cdot \left\{ \cos[2\pi((\alpha_1 - \alpha_2)t + (f_0^1 - f_0^2)\tau)] \right. \\ &\quad \left. + \cos[2\pi((\alpha_1 + \alpha_2)t + (f_0^1 + f_0^2)\tau)] \right\} \end{aligned} \quad (3)$$

If both swept sources start at approximately the same frequency ( $f_0^1 \sim f_0^2$ ), the unwanted phase modulations are greatly reduced in the first cosine term above when compared to the single laser case of equation 1. The second cosine term may easily be removed with a filter as it typically resides in a different region of frequency space.

However, a high quality tunable laser source is a very expensive piece of equipment that greatly increases the cost of a dual swept laser system. Likewise, the additional components required to perfectly synchronize both sources will further increase the cost and complexity of the system.

Using FWM to generate a second swept source using an original swept frequency signal and a fixed frequency laser reduces the cost and complexity of the system. FWM is an intermodulation non-linear optical effect associated with Kerr effect that takes places in mediums with high  $\chi^{(3)}$  coefficient (third order nonlinear susceptibility). In its general form, given three inputs at different optical frequencies ( $f_1$ ,  $f_2$  and  $f_3$ ) propagating through said medium, new optical components will appear at the output with main peaks at  $f_{ijk} = f_i + f_j - f_k$

(with  $i \neq j \neq k$ ). Degenerative FWM (DFWM) is the specific variation of the effect that we will be using; it occurs when there are only two inputs. In this case the main generated peaks are  $2f_1 - f_2$  and  $2f_2 - f_1$ . FWM is commonly used in optical communications for wavelength conversion, however in this case we will apply it to frequencies without modulation [6], [7]. Using a fixed laser as  $f_1$  and a swept source as  $f_2$ , an additional swept source is generated at  $2f_1 - f_2$ . It will be a mirrored (about the  $f_1$  reference) inverted copy of  $f_2$ . Since the generated sweep is a perfect copy of the original and created simultaneously, there are no synchronization issues to resolve. Also, only one swept frequency laser source is required which reduces the cost and complexity of the dual FSI system.

### III. EXPERIMENTAL SET-UP

Using FWM to generate a second swept source to perform dual FSI measurements, the experimental set-up in figure 3 has been built to perform distance measurements to a glass sphere retro reflecting target [8]. The C-band has been chosen as the wavelength space due to eye safety considerations and for the availability and low cost of components (due to many telecom devices operating in this band).

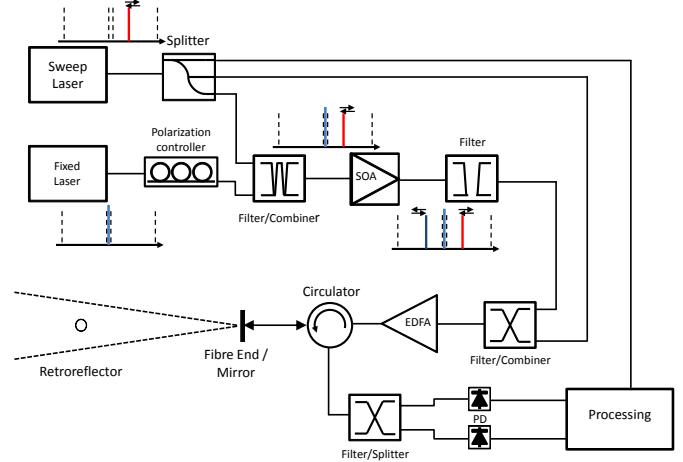

Figure 3. Experimental set-up. The Semiconducting Optical Amplifier (SOA) acts as the non-linear medium. The Erbium-Doped Fibre Amplifier (EDFA) further amplifies the output dual wavelength sweeps for FSI measurements.

A DFB laser (JDSU CQF 935) with a 16 dBm output power and a 1545.32 nm wavelength (dense wavelength division multiplexing (DWDM) channel closest to the center of C-Band) is used as the fixed component. Polarization is controlled to match the polarization state in the swept laser source at the input of the non-linear medium (to maximize the FWM effect). The swept frequency source (Newfocus TLM8700, output power 3 dBm) sweeps at higher wavelengths than the fixed laser (1548-1563 nm). In this way the original and the generated swept frequencies will cover the whole C-Band. The swept source is split into three components, one is used as a reference for the processing (to obtain a valid clock and to synchronize and linearize the detection), another is kept as a clean sweep and the third is used to generate the FWM copy. A standard communication DWDM filter combines the fixed and original sweep at the input of our non-linear medium, a Semiconductor Optical

Amplifier (SOA, Kamelian SOA-NL) specially designed to potentiate FWM. The output of the SOA has three wavelength components: the fixed DFB wavelength, the original swept frequency, and the new generated sweep. A DWDM filter suppresses the fixed wavelength component, while the generated sweep is isolated using red/blue C-band filters. The original clear sweep is then combined with the generated, so two perfectly inverted sweeps are present at the input of the Erbium-Doped Fibre Amplifier (EDFA). The amplified signals go through a circulator to discriminate outgoing and incoming signals. The fibre end (a FC/PC connector) acts both as the reference mirror (reflecting part of the light back to the circulator) and as the sensor head transmitting light towards the targets. The target is an  $n \approx 1.955$  retro reflecting sphere that returns incoming beams from all directions. Reflections are divided so the signal generated by each swept source is detected individually on a separate photodiode (PD), the electrical beat signal is passed to the processing block where sampling and synchronization takes place and a spectral response from which a distance estimation is obtained.

To test the ability of the setup to compensate for vibrations from the system, a single target has been attached to a lead zirconate titanate (PZT) piezoelectric positioner stage. Vibrations were induced under various conditions in order to evaluate the FWM dual sweep technique. Also different continuous displacements were tested to evaluate the behavior of our dual sweep proposal against movement.

#### IV. RESULTS

##### A. Vibration

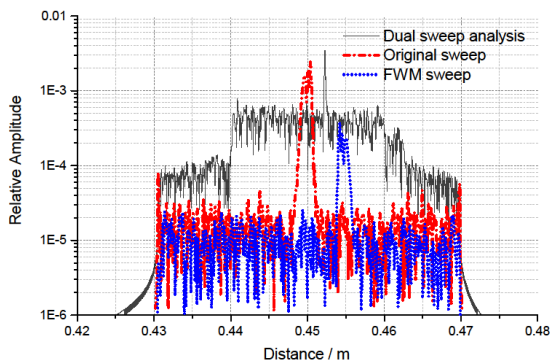

Figure 4. Detected spectra from a single measurement with the PZT vibrating at 2 Hz over a 106  $\mu\text{m}$  range.

Figure 4 shows the detected crude spectra for different possible FSI methods applied to a 2 Hz 106  $\mu\text{m}$  peak to peak vibrating target. Vibration was induced by placing the target on a PZT which was driven using a sinusoidal signal generator. Even with this kind of raw data it can be clearly appreciated that the dual sweep FSI analysis gives a narrow frequency signal while both the individual signals show a broadened response (broadened in opposing directions due to the fact that they have the exact same sweeping rate with different sign).

Figure 5 shows the detected positions of a target attached to a PZT moving with a frequency of 2 Hz. The laser swept a wavelength range of 13 nm at a rate of  $500 \text{ nm}\cdot\text{s}^{-1}$ . With the dwell time of the laser, the sampling rate of the system was

$\sim 9.6 \text{ Hz}$ . The range of PZT oscillation was measured by moving the PZT to the extreme range of its movements and measuring the target stationary in these positions. The average FWM-FSI values for these positions are highlighted in Figure 5 as the dashed black lines. The possible range of PZT oscillation was calculated to be 21  $\mu\text{m}$  from these measurements.

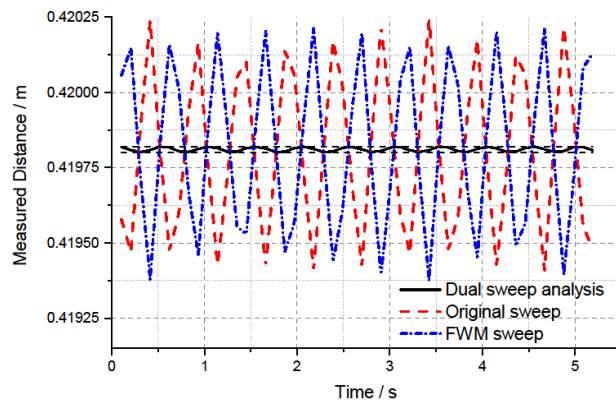

Figure 5. Distance vs. time plot of FSI single and dual sweep distance estimations of PZT oscillations at 2 Hz with 9  $\mu\text{m}$  oscillation range. Central dashed lines indicate stationary measured range of the PZT.

It can be clearly seen that the single sweep measurements present a large divergence of target distance relative to the dual FWM-FSI measurements, which stays within the PZT oscillation range. The single sweep measurements record oscillation ranges of 339  $\mu\text{m}$  ( $>35$  times the real oscillations of the target). This is due to Doppler shifting of the signal frequency. On the other hand the dual FWM-FSI measurements agree well with the PZT movement, keeping within the limiting range of the target oscillation.

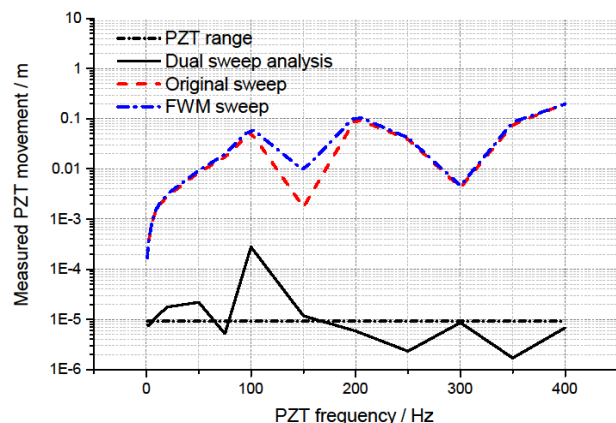

Figure 6. Evolution of the degradation of the single sweep measurements vs frequency for PZT amplitude range of 9  $\mu\text{m}$ .

This exaggerated shift in distance continues to increase as the speed and the amplitude of the vibrations increases (see figure 6). When the PZT oscillates at a frequency much greater than that of the sampling frequency, the measured PZT range becomes dependent on the difference in oscillation frequency and sampling frequency. Furthermore, the spread of detected frequencies in the FSI analysis becomes larger with increased target oscillation frequency. This reduces the target Signal to Noise Ratio (SNR), making it harder to determine the peak location (except when an exact multiple between the

target oscillation and sampling rate is reached). The dual FWM-FSI measurements on the other hand cope well with the full range of different PZT oscillation frequencies, also suffering less from loss of SNR with higher frequencies.

### B. Movement

We have seen that the vibration of the target induces high errors in the estimated range. In this section we report the results for a target moving at constant velocity. The same Doppler contributions that affected the vibration measurements are present here, but now that the target is moving faster and at a constant rate, instead of a broadening of the spectrum we have a big displacement of the peak. We have used a movement stage that translates the target between two points at a fixed speed of approximately  $30 \text{ mm}\cdot\text{s}^{-1}$ . The plot in figure 7 shows that initial and final positions (when the target is stationary) present a similar estimation for the single and dual sweep analysis. But when the target is travelling large displacements appear in both single sweep measurements: in the order of 5 cm when the target has a high velocity, something that can potentially make the error bigger than the total displacement of the target. The dual FSI analysis reduced this problem, providing a more accurate estimation of the target movement.

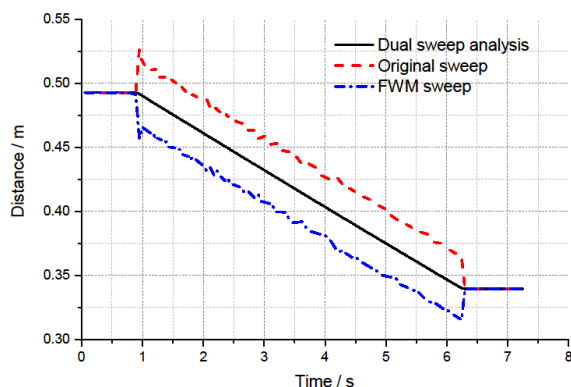

Figure 7 Distance estimation vs. time for a target moving

## V. CONCLUSIONS

We have been able to build a complete dual sweep FSI system using a single swept frequency laser source and a mirrored copy of this frequency sweep generated by DFWM.

Experimental results show a notable increase of the robustness of a FSI distance measurement system based in frequency detection when a double sweep is used. The frequency signal produced by combining the two signals from the dual sweep system presents a clear and stable peak in the frequency spectrum under circumstances that render the individual signals completely unusable due to excessive broadening or shifting of the peak. This proves that the quality of the mirrored copy of the original swept frequency source made using FWM is suitable for use in FSI.

The set-up has been built using standard optical communication devices (low cost, easily available) that represent a significant reduction of the costs over two swept laser solutions. Also due to the nature of the perfectly mirrored

copy generated through FWM no additional synchronization is required (the components that are used to synchronize a single sweep FSI are the same used in the dual sweep) which further reduces the cost and the complexity of the system. Finally the instant response of the FWM implies that changing the specifications of the original sweep source (improving its speed for example) will still produce a perfect copy, allowing for an easier to upgrade, flexible system.

A range measurement device built with this technology will be less expensive, less bulky and simpler than one that requires two sources. At the same time it will maintain the intolerance to changes in OPD typical in a dual FSI, making it ideal for industrial applications. A patent for the invention has been solicited [9].

For future developments of the system, higher qualities and resolutions could be achieved by the use of different non-linear mediums (that allow increasing the quality and range of the generated sweep) and further cost reduction could be possible with the use of integrated serial produced components for the passives and fixed laser.

## REFERENCES

- [1] M. Norgia, G. Giuliani, and S. Donati, "Accuracy Using Laser Diode Self-Mixing Interferometry in a Closed Loop," *IEEE Trans. Instrum. Meas.*, vol. 56, no. 5, pp. 1894–1900, 2007.
- [2] J. Zheng, "Analysis of optical frequency-modulated continuous-wave interference," *Appl. Opt.*, vol. 43, no. 21, pp. 4189–4198, 2004.
- [3] J. Zheng, "Optical frequency-modulated continuous-wave interferometers," *Appl. Opt.*, vol. 45, no. 12, pp. 2723–2730, 2006.
- [4] J. Thiel, T. Pfeifer, and M. Hartmann, "Interferometric measurement of absolute distances of up to 40 m," *Measurement*, vol. 16, no. 1, pp. 1–6, Sep. 1995.
- [5] R. Schneider, P. Thurmel, and M. Stockmann, "Distance measurement of moving objects by frequency modulated laser radar," *Opt. Eng.*, vol. 40, no. 1, p. 33, Jan. 2001.
- [6] L. Krzaczanowicz and M. J. Connelly, "40 Gb/s NRZ-DQPSK Data All-Optical Wavelength Conversion Using Four Wave Mixing in a Bulk SOA," *IEEE Photonics Technol. Lett.*, vol. 25, no. 24, pp. 2439–2441, Dec. 2013.
- [7] C. Porzi, A. Bogoni, and G. Contestabile, "Regenerative Wavelength Conversion of DPSK Signals Through FWM in an SOA," *IEEE Photonics Technol. Lett.*, vol. 25, no. 2, pp. 175–178, Jan. 2013.
- [8] T. Takatsuji, M. Goto, S. Osawa, R. Yin, and T. Kurosawa, "Whole-viewing-angle cat's-eye retroreflector as a target of laser trackers," *Meas. Sci. Technol.*, vol. 10, no. 7, pp. N87–N90, Jul. 1999.
- [9] "Dual laser frequency sweep interferometry system and method," GB1411206.4, 2014, <http://www.ipo.gov.uk/p-ipsum/Case/ApplicationNumber/GB1411206.4>.